

PARTITA V S0 SEHPA

PARTITA V S0 SEHPA

Tasarım;	Ev için tasarlanmıştır. Kapalama, mermer ve cam tabla seçenekleri vardır.
Malzeme & Bitişler;	a- Doğal Kaplama Masa Tablası; 25mm MDF üzeri doğal kaplama b- Mermer Masa Tablası; 5mm Mermer + 5mm Kompozit c- Cam Tabla; 10mm Temperli Boyalı Cam d- Mermer ve Cam Destek Tablası; 25mm MDF üzeri siyah lake e- Ayaklar; Alüminyum profil üzeri kaplama ayaklar f- Metal kayıtlar; 20x50x2mm kutu profil üzeri epoksi
Montaj Elemanları;	a- Ayak bağlantısı plastik kelepçe ve metrik cıvata, çelik burç.



PARTITA V S0 SEHPA

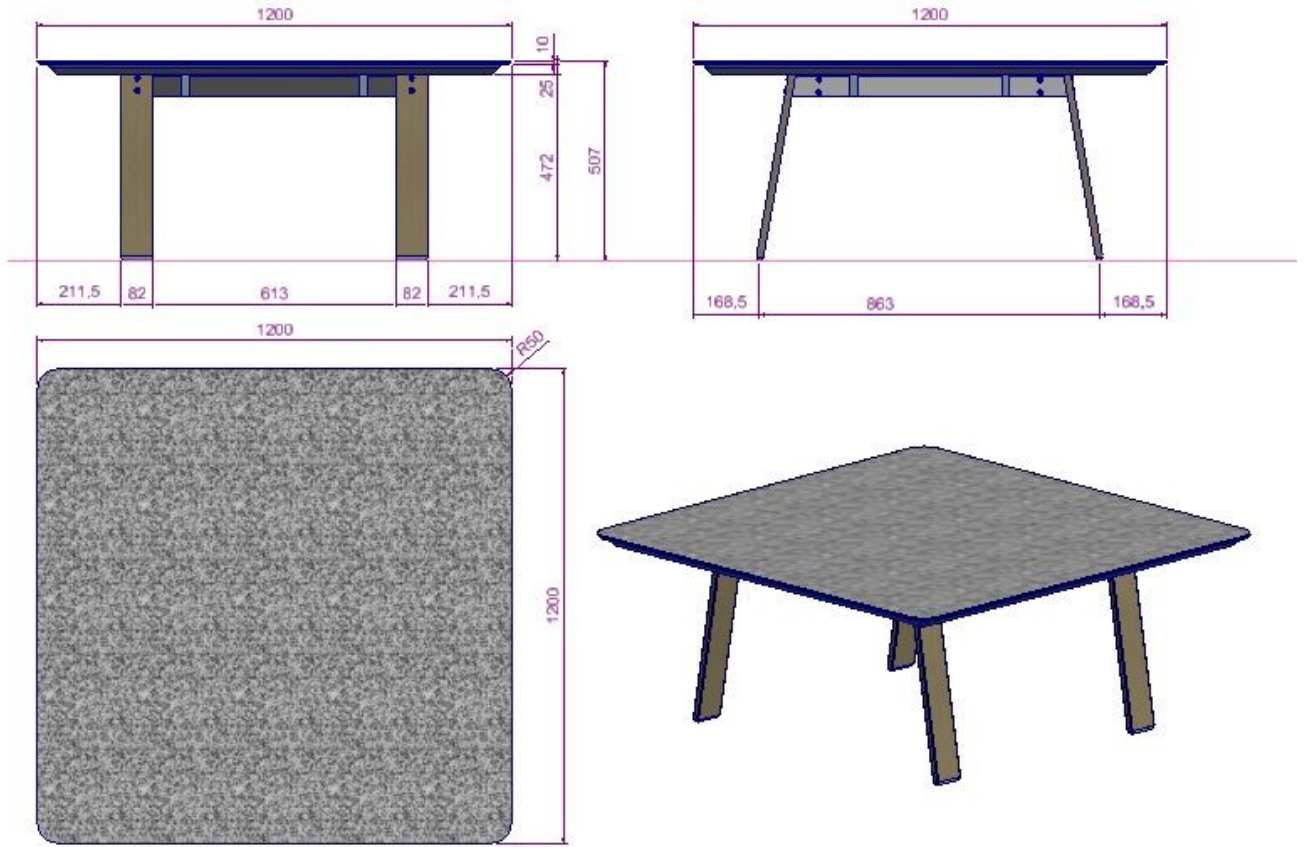

PARTITA V S0 CTPV120M

L:1200 D:1200 H:500 mm

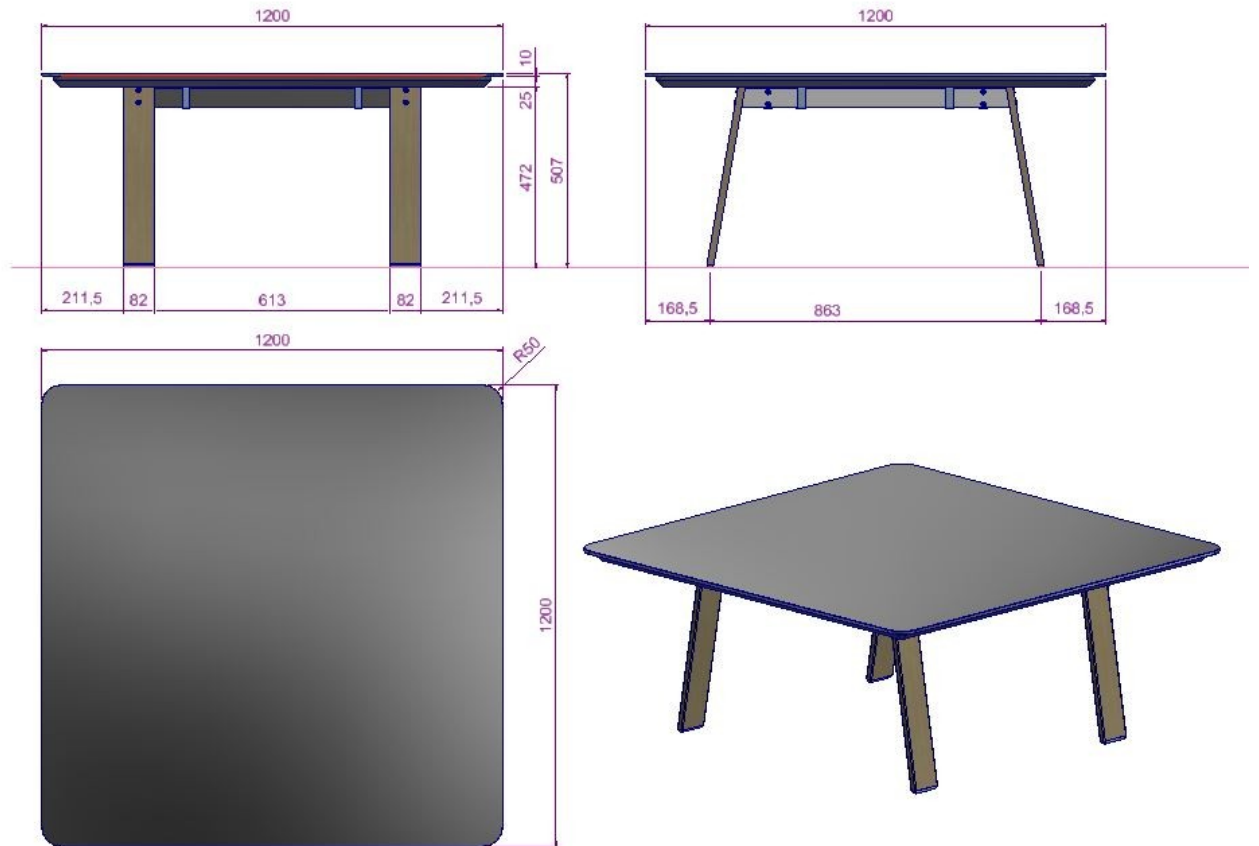

PARTITA V S0 CTPV120G

L:1200 D:1200 H:500 mm

PARTITA V S0 SEHPA

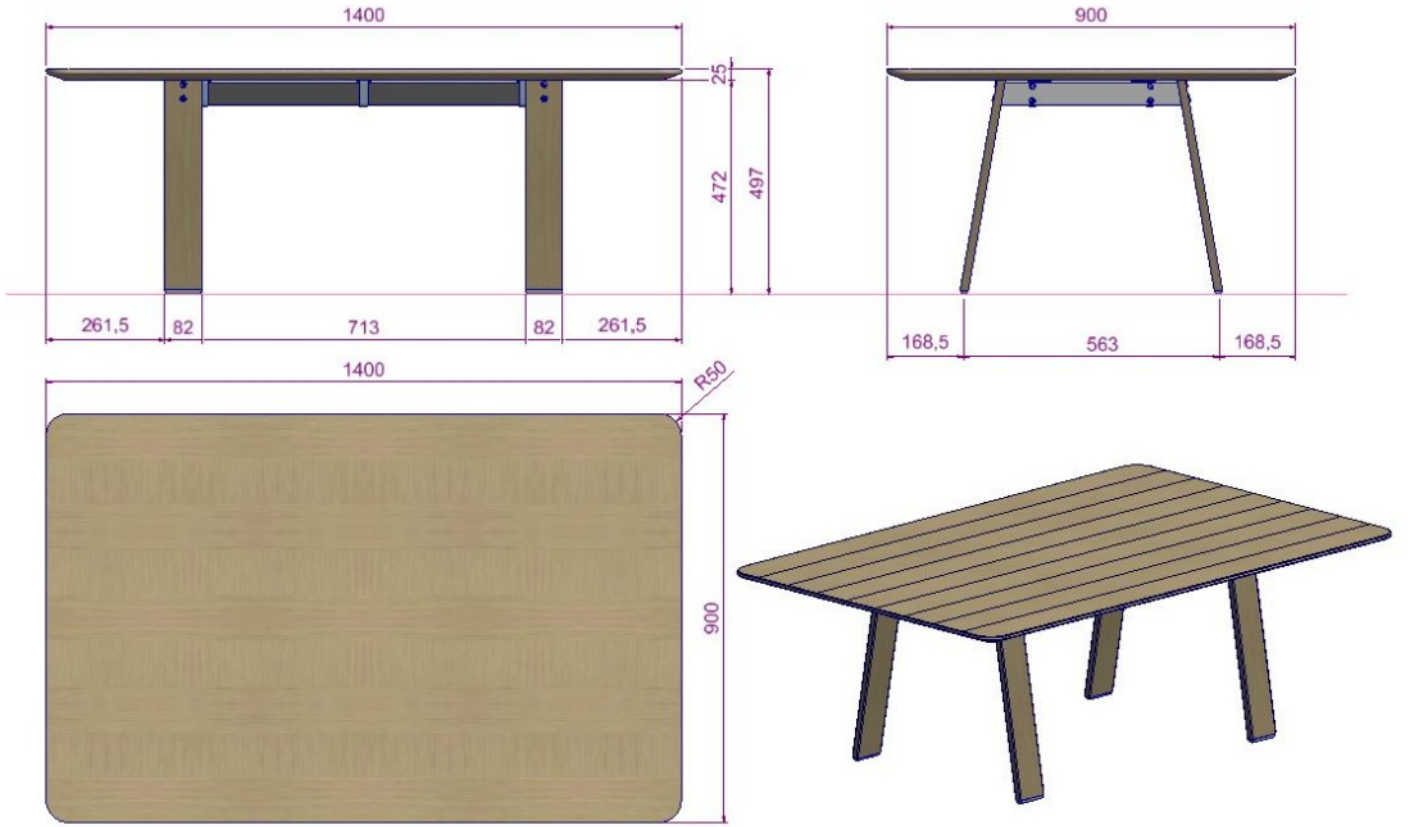

PARTITA V S0 CTPV140V

L:1400 D:900 H:500 mm

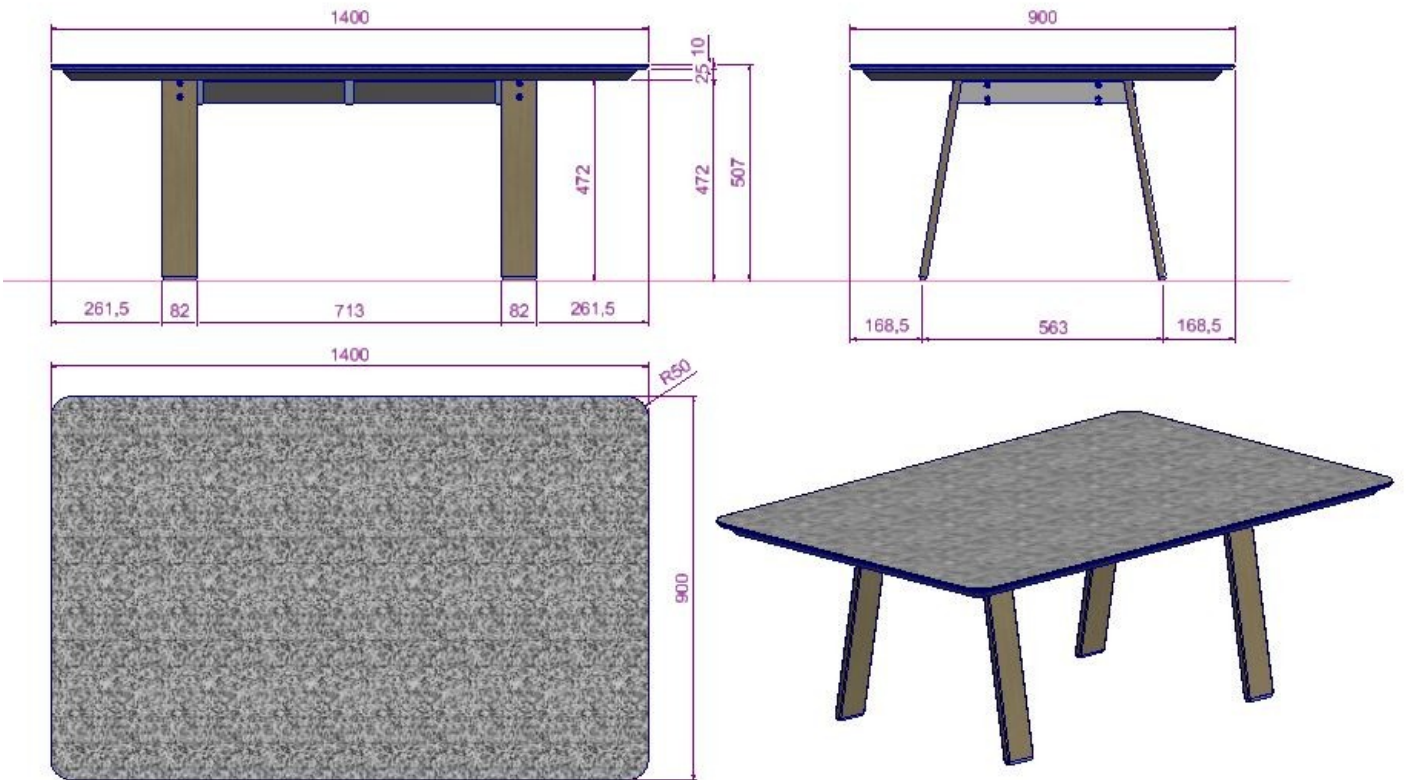

PARTITA V S0 SEHPA

PARTITA V S0 CTPV140M

L:1400 D:900 H:500 mm

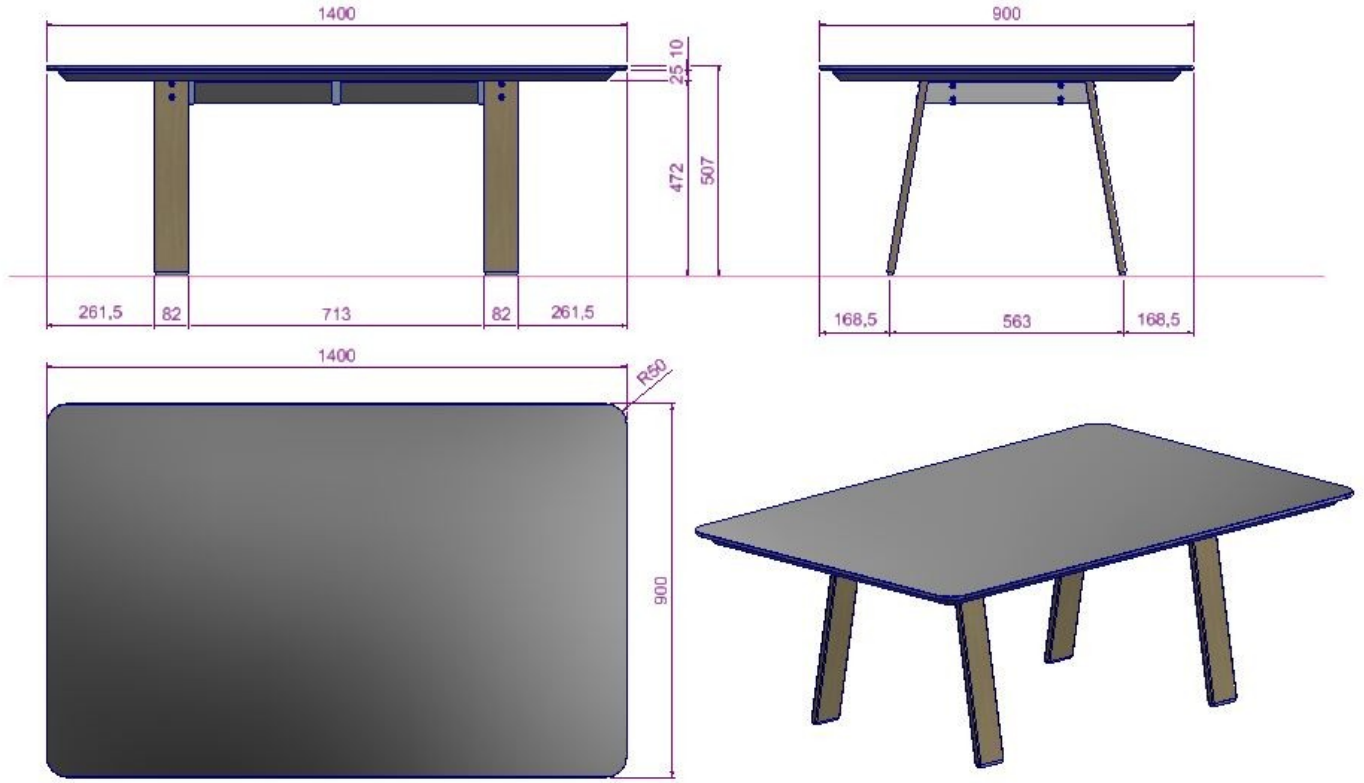

PARTITA V S0 CTPV140G

L:1400 D:900 H:500 mm

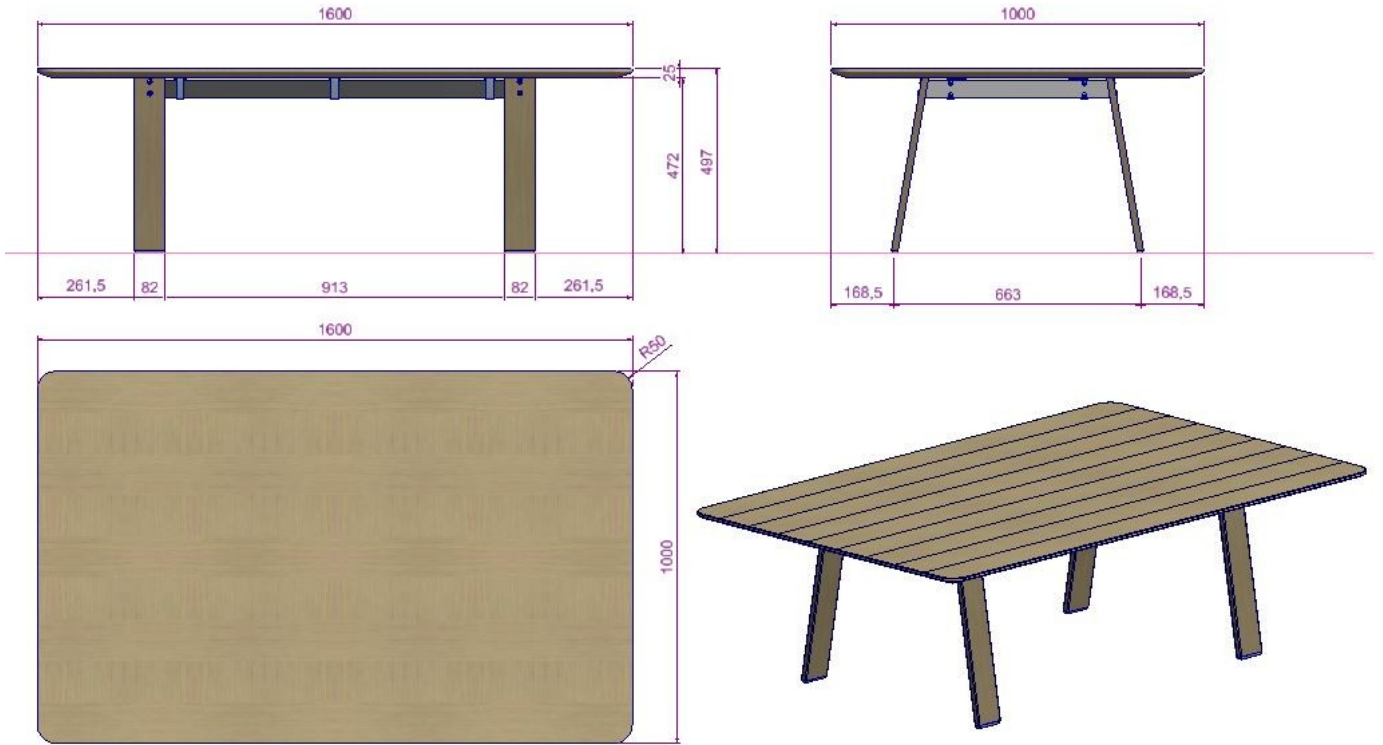

PARTITA V S0 CTPV160V

L:1600 D:1000 H:500 mm

PARTITA V S0 SEHPA

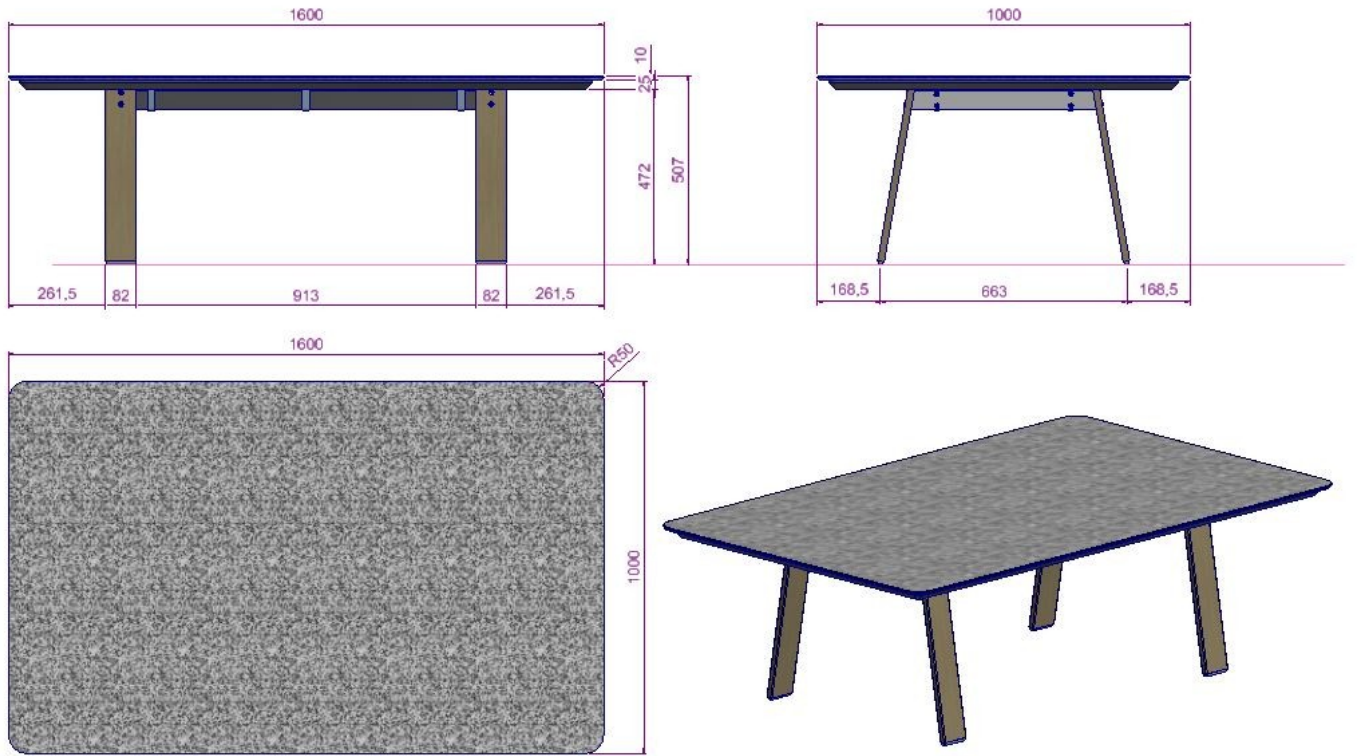

PARTITA V S0 CTPV160M

L:1600 D:1000 H:500 mm

